

CDL3404A-ME

MOSFET

Marking: A49T

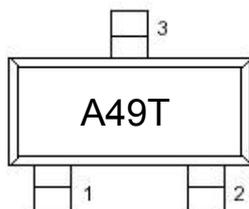

Top view

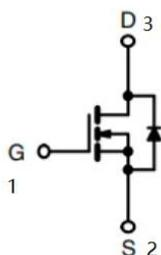

SOT-23 Dimension

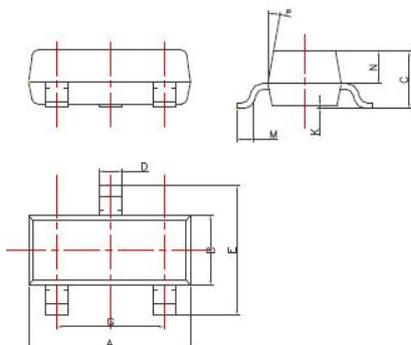

DIM	Millimeters
A	2.85~3.04
B	1.30±0.10
C	1.00±0.10
D	0.45±0.05
E	2.25~2.55
G	1.90±0.1
K	0.00-0.10
M	0.20 MIN
N	0.60±0.10
P	7±2°

SOT-23 Suggested Layout

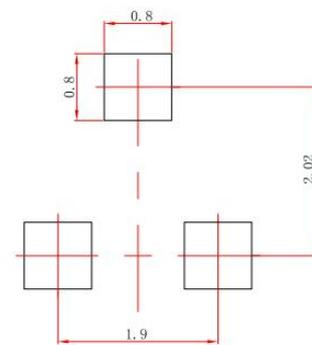

mm(±0.05mm)

MAXIMUM RATINGS (T_a=25°C)

Characteristic	Symbol	Rating	Unit
Drain-Source Voltage	V _{DS}	30	Vdc
Gate-Source Voltage	V _{GS}	±20	Vdc
Drain Current—Continuous	I _D	5.8	Adc
Peak Drain Current	I _{DM} ¹	30	Adc

THERMAL CHARACTERISTICS

Characteristic	Symbol	Max	Unit
Total Device Dissipation T _A =25°C	P _D	350	mW
Thermal Resistance from Junction to Ambient	R _{θJA}	357	°C/W
Junction and Storage Temperature	T _J , T _{stg}	150, -55 to +150	°C

1. Repetitive Rating : Pulse width limited by maximum junction temperature

ELECTRICAL CHARACTERISTICS (T_A=25°C unless otherwise noted)

Characteristic	Symbol	Test Condition	Min	Type	Max	Unit
Drain-Source Breakdown Voltage	V _{(BR)DSS}	V _{GS} =0V, I _D =250μA	30	-	-	V
Zero Gate Voltage Drain Current	I _{DSS}	V _{DS} =24V, V _{GS} =0V	-	-	1.0	μA
Gate-Body Leakage Current, Forward	I _{GSS}	V _{GS} =±20V	-	-	±100	nA
Gate Threshold Voltage	V _{GS(th)}	V _{DS} =V _{GS} , I _D =250μA	1	1.4	3	V
Static Drain-Source On-State Resistance	R _{DS(on)}	V _{GS} =10V, I _D =5.8A V _{GS} =4.5V, I _D =4.8A	-	24 32	30 42	mΩ
Forward Transconductance	g _{fs}	V _{DS} =5V, I _D =5.8A	5	-	-	S
Diode Forward On-Voltage	V _{SD}	V _{GS} =0V, I _S =1.0A	-	-	1	V
Turn-On Delay Time	t _{d(on)}	V _{DD} = 10V, V _{DS} =15V, I _D =5A, R _L = 2.7Ω, R _{GEN} = 3Ω	-	-	6.5	ns
Turn-On Time	t _r		-	3.1	-	
Turn-Off Delay Time	t _{d(off)}		-	15.1	-	
Turn-On Fall Time	t _f		-	2.7	-	
Input Capacitance	C _{iss}	V _{DS} = 15V, V _{GS} = 0V, f = 1.0 MHz	-	-	820	pF
Output Capacitance	C _{oss}		-	118	-	
Reverse Transfer Capacitance	C _{rss}		-	85	-	

CDL3404A-ME

MOSFET

Typical Performance Characteristics

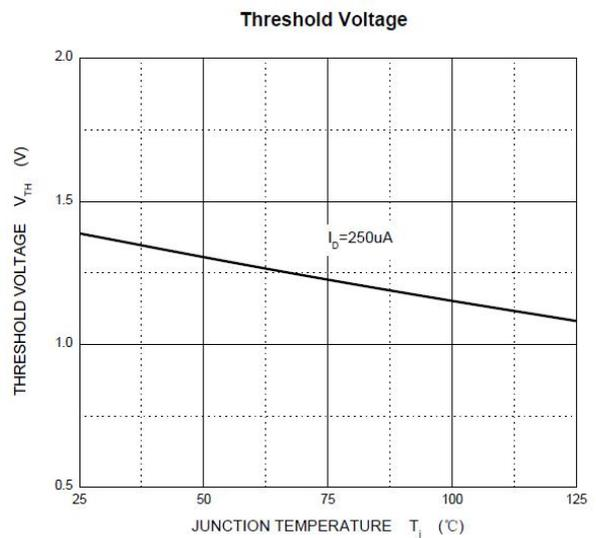
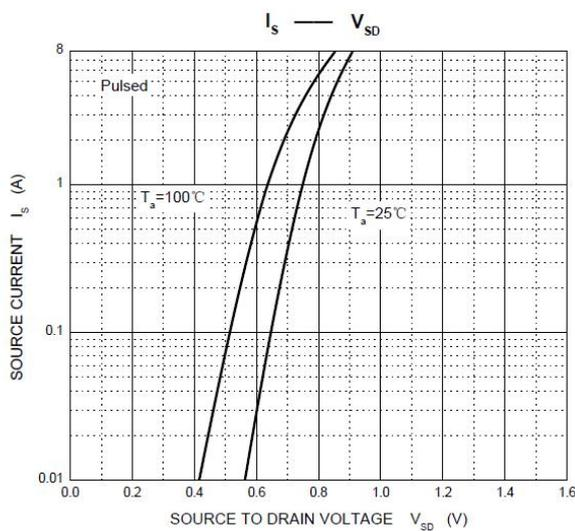
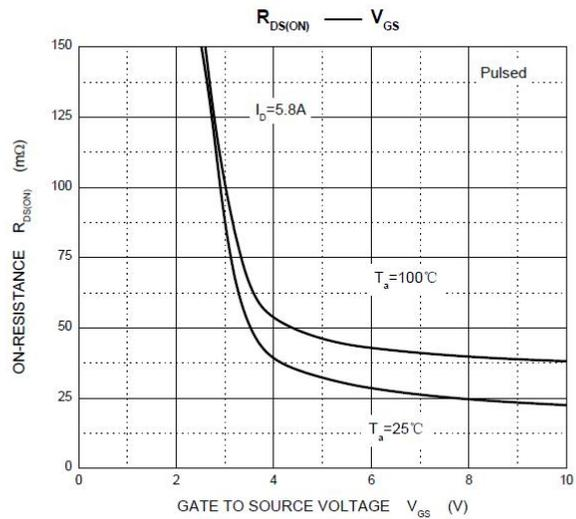
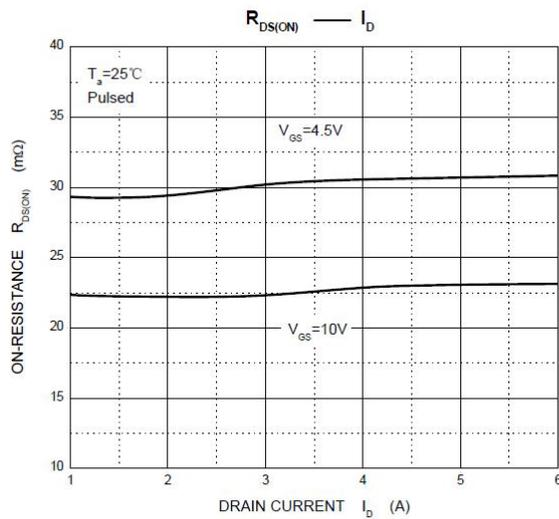
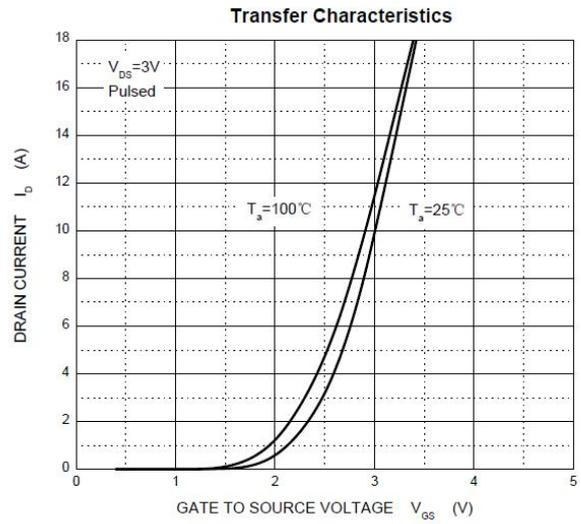
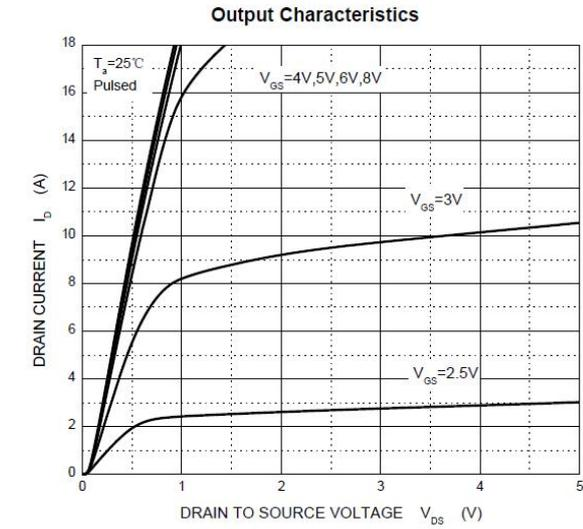

Note: Specifications are subject to change without notice. For more detail and update, please visit our website.