

CDBAT54C-ME

Schottky Diode

Marking: KL3

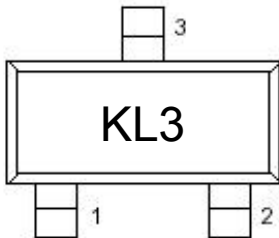

Top view

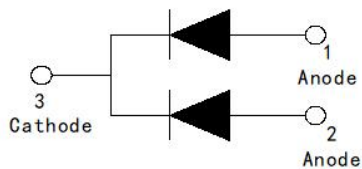

SOT-23 Dimension

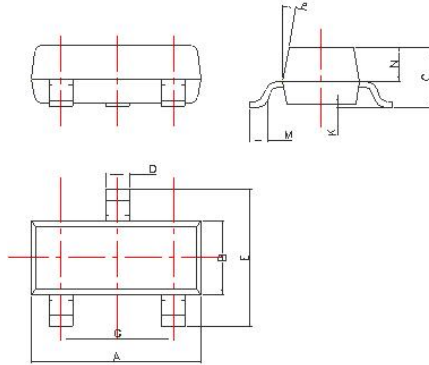

DIM	Millimeters
A	2.85~3.04
B	1.30±0.10
C	1.00±0.10
D	0.45±0.05
E	2.25~2.55
G	1.90±0.1
K	0.00-0.10
M	0.20 min
N	0.60±0.10
P	7±2°

SOT-23 Suggested Layout

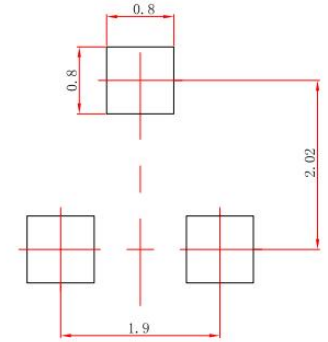

mm(±0.05mm)

MAXIMUM RATINGS (Ta=25°C)

Characteristic	Symbol	Rating	Unit
Reverse Voltage	V_R	30	Vdc
Peak Forward Current	I_F	200	mAdc

THERMAL CHARACTERISTICS

Characteristic	Symbol	Max	Unit
Total Device Dissipation FR-5 Board(1) TA=25°C	P_D	225	mW
Total Device Dissipation Alumina Substrate,(2) TA=25°C	P_D	300	mW
Junction and Storage Temperature	T_J , T_{slg}	150 · -55 ~150	°C

- FR-5=1.0×0.75×0.062in, printed-circuit board.
- Alumina=0.4×0.3×0.024in, 99.5%alumina

ELECTRICAL CHARACTERISTICS (Ta=25°C unless otherwise noted)

Characteristic	Symbol	Test Condition	Min	Type	Max	Unit
Reverse Voltage Leakage Current	I_R	$V_R=25Vdc$	--	--	1.0	μA
Reverse Breakdown Voltage	$V_{(BR)}$	$I_{BR}=10\mu Adc$	30	--	--	Vdc
Forward Voltage	V_F	$I_F=0.1mAdc$	--	--	240	mV
		$I_F=1.0mAdc$	--	--	320	
		$I_F=10mAdc$	--	--	400	
		$I_F=30mAdc$	--	--	500	
		$I_F=100mAdc$	--	--	1000	
Total Capacitance	C_T	$V_R=1V, f=1.0MHz$	--	--	10	pF
Reverse Recovery Time	t_{rr}	$I_F=I_R=10mAdc$, $R_L=100\Omega$	--	--	5.0	nS

CDBAT54C-ME

Schottky Diode

Typical Characteristics

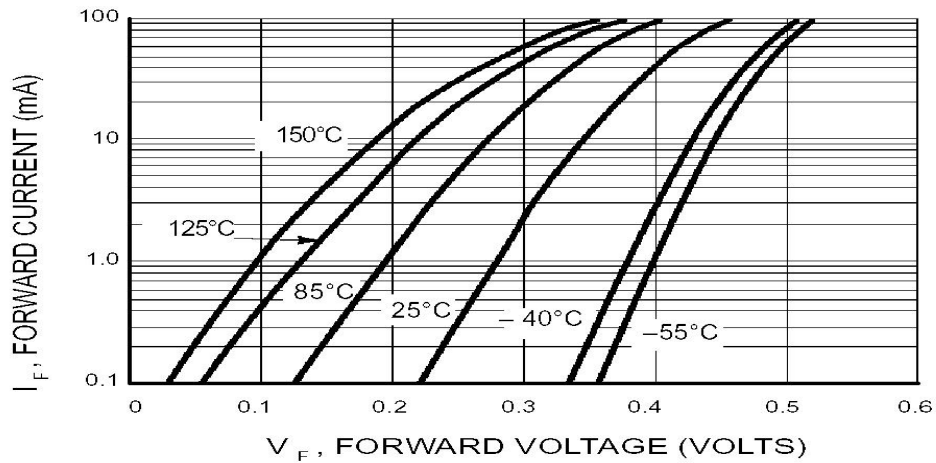
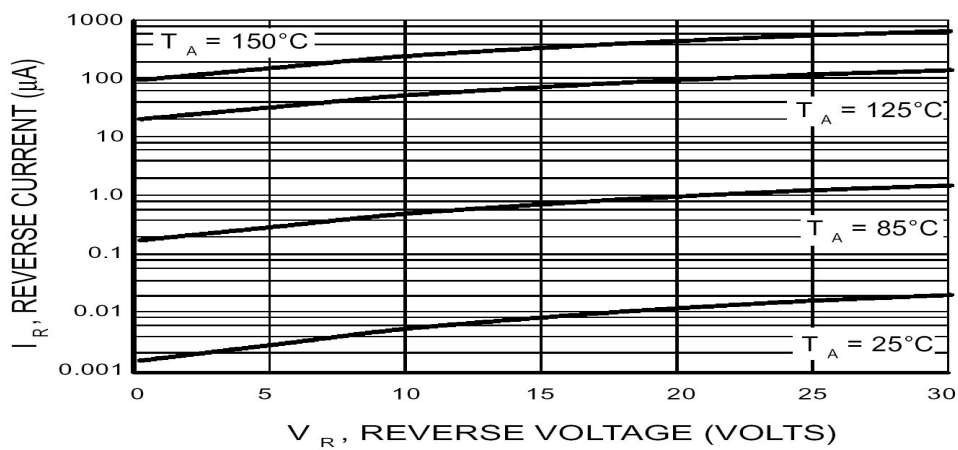
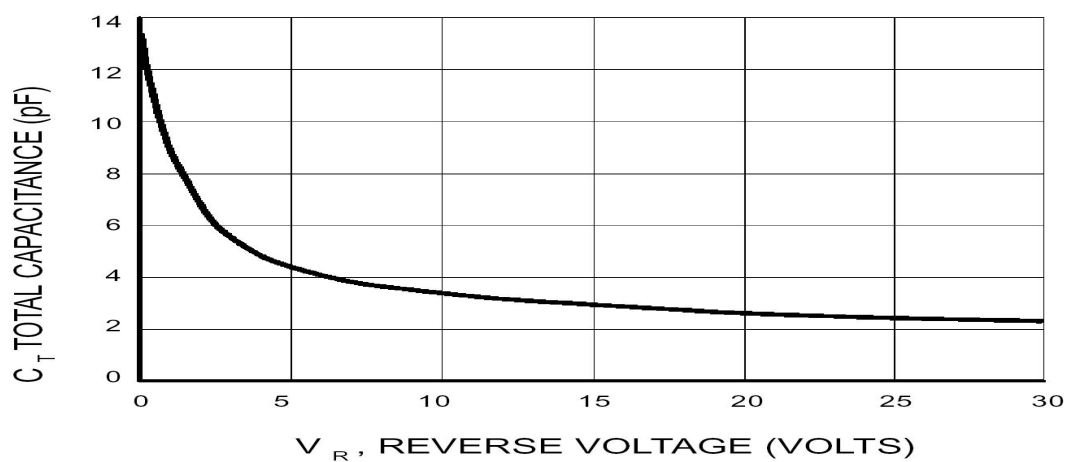
Fig.1 I_F — V_F Fig.2 I_R — V_R Fig.3 C_T — V_R

Note: Specifications are subject to change without notice. For more detail and update, please visit our website.