

# TSL-3528UB000MTH



**FEATURES**

- Wide Viewing Angle 120°
- Reflow Solderable
- High Luminous Intensity and Low Power Dissipation
- Good Reliability and Long Life
- Complied With RoHS Directive

**APPLICATIONS**

- Optical indicator
- Indoor display
- Backlighting in dashboard and switch
- Flat Backlighting for LCD, symbol and display
- General use

**TECHNICAL DATA SHEET**

This product is generally used as indicator and luminary for electronic equipment such as household appliance, communication equipment and dashboard.

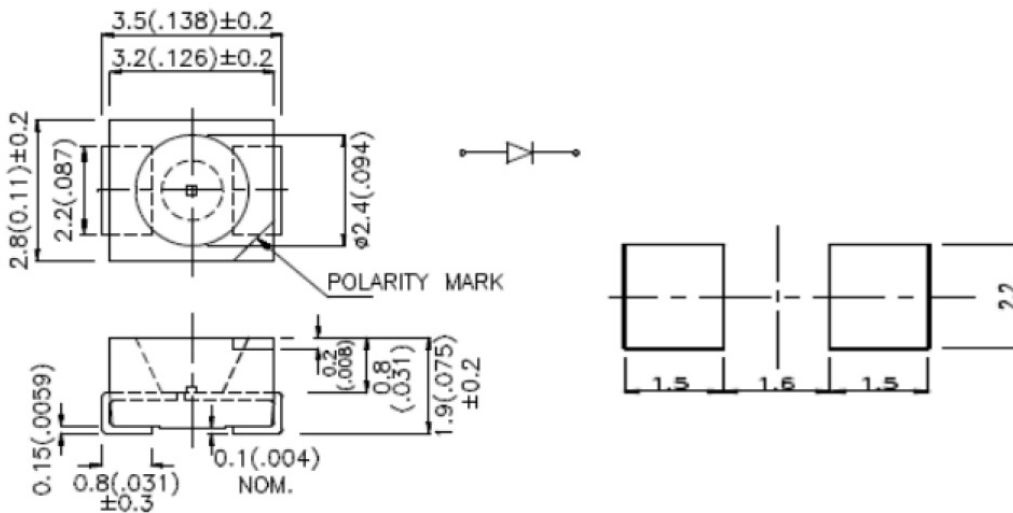

**Notes:**

1. All dimension units are millimeters.
2. All dimension tolerance is ±0.2mm unless otherwise noted.

**Selection Guide**

Dice	Lens Type	Luminous intensity (mcd) @ 20mA			Viewing Angle
		Min	Typ	Max	2θ1/2
Blue (InGaN)	Water Clear	240	480	800	120

**Note:**

1. 1/2 is the angle from optical centerline where the luminous intensity is 1/2 the optical centerline value.
2. The above luminous intensity measurement allowance tolerance ±10%

**Electrical / Optical Characteristics at Ta=25°C**

Parameter	Symbol	Min.	Typ.	Max	Units	Test conditions
Forward Voltage	VF	2.8	3.2	3.6	V	IF=20mA
Reverse Current	IR	--	--	10	uA	VR=5V
Dominant Wavelength	λd	465	--	475	nm	IF=20mA

**Absolute Maximum Ratings at Ta=25°C**

Parameter	Symbol	Rating	Units
Power Dissipation	Pd	160	mW
DC Forward Current	IF	25	mA
Peak Forward Current 【1】	IFP	100	mA
Reverse Voltage	VR	5	V
Electrostatic Discharge (HBM)	ESD	±1000	V
Operating Temperature	Topr	-30~+85	°C
Storage Temperature	Tstg	-40~+100	°C

**Note:**

1. 1/10 Dut cycle, 0.1ms pulse width.
2. The above forward voltage measure ment allowance tolerance ±0.1V.

# TSL-3528UB000MTH

## Typical Optical Characteristics Curves

Ambient Temperature VS. Forward Current

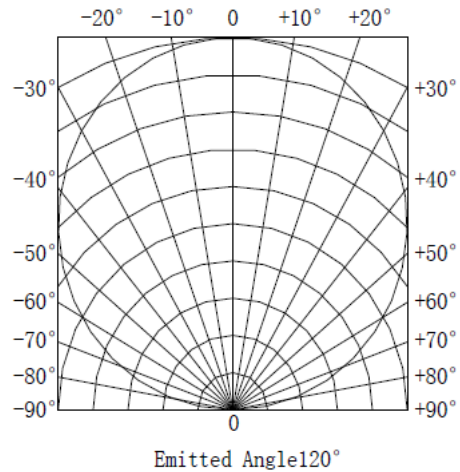
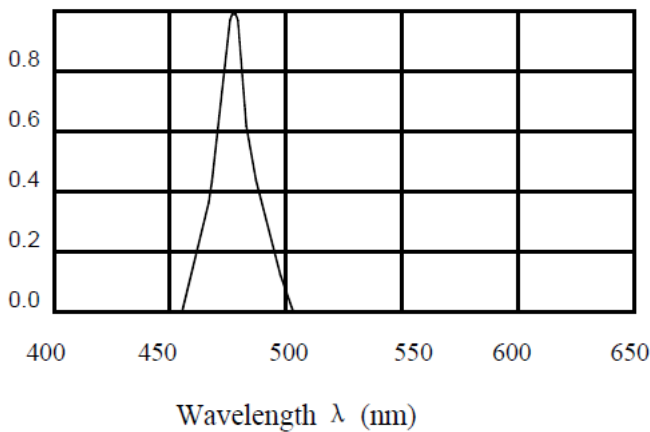
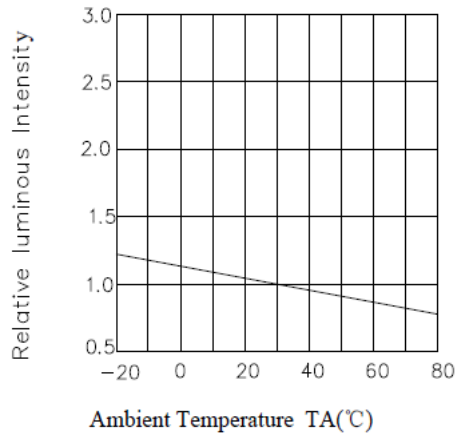
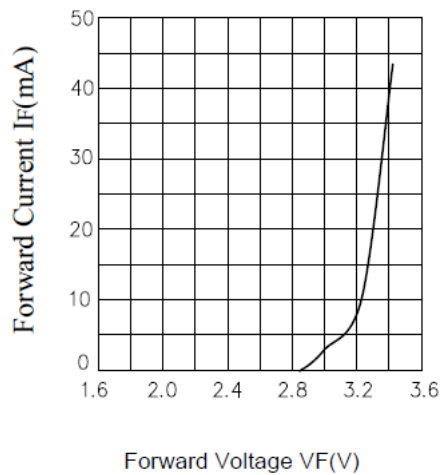
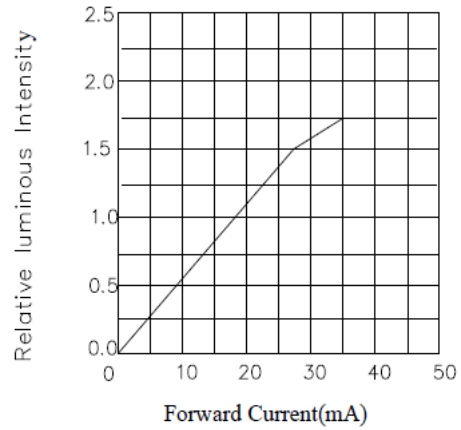
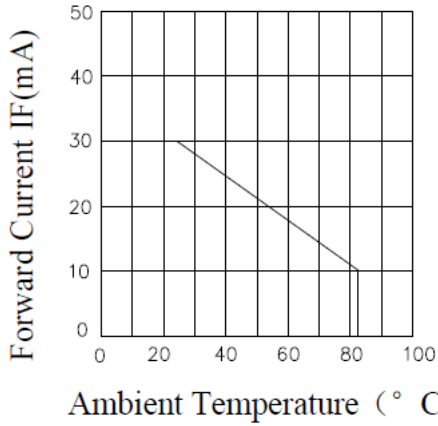

# TSL-3528UB000MTH

Carrier Tape

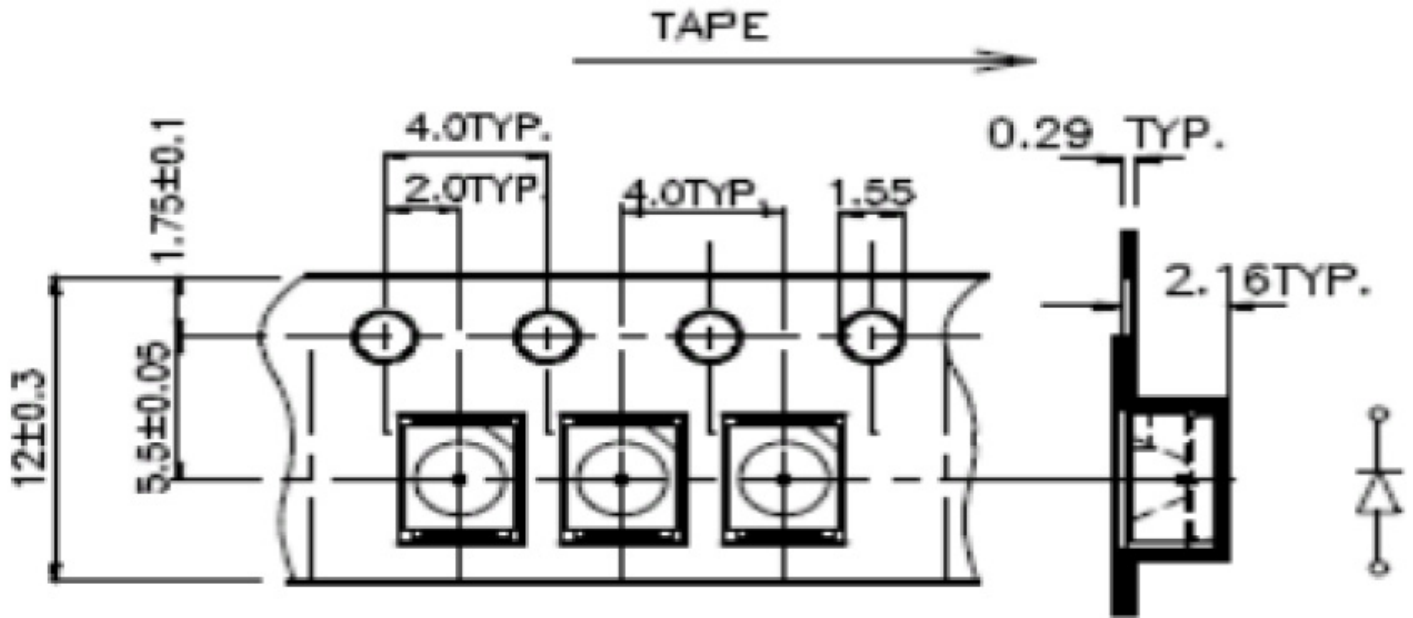

## Moisture Resistant Packaging

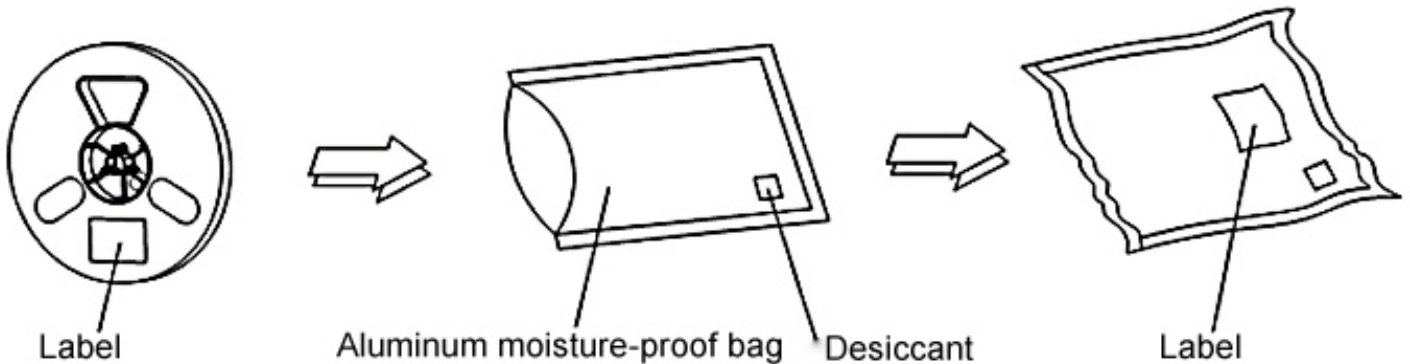

Note: Specification are subject to change without notice. For more detail and update, please visit our website.